

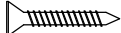







Wall Cabinet Assembly Instruction

(Item:W2430-W3330 W2436-W3336)

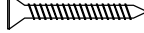
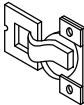
Hardware list	1 8pcs $\varnothing 4 \times 16 \text{mm}$ Flat head screw	2 4pcs $\varnothing 4 \times 19 \text{mm}$ Round head screw	3 8pcs $\varnothing 3.5 \times 14 \text{mm}$ Color galvanized screw with flat head	3 6pcs $\varnothing 3.5 \times 16 \text{mm}$ Color galvanized screw with flat head	4 4pcs $\varnothing 3.5 \times 35 \text{mm}$ Black screw with flat head	5 4pcs 1-1/4" Hinge	6 8pcs 6mm Shelf clips
							
Assembly tools required	Screw driver	Rubber mallet			9 4pcs 40mmx40mm Bracket rainbow 90°	8 2pcs $\varnothing 7$ Bumper	7 2set L-shape bracket
							
Cabinet Part List	A Front frame	B Side panel(2)	C Top-Bottom panel	D Back panel	E Adjustable shelf	F Door	

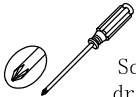
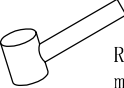
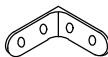
Step 1 : With front frame (A) of cabinet lay down on clean and soft surface then put glue into groove.

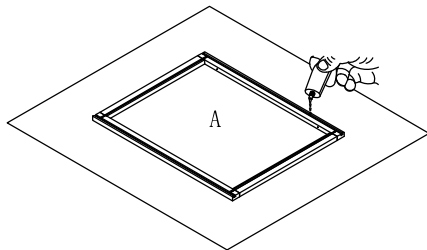

Step 2 : Install side panel. Insert two side panels (B) into groove of front frame (A) until side panel (B) and front frame (A) even.

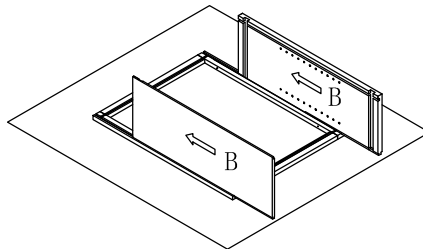

Step 3 : Install top and bottom panel. Insert top and bottom panel (C) into groove of side panel (B) until it into the groove of front frame (A).

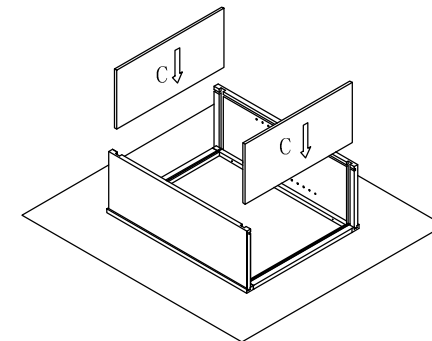

Step 4 : Install back panel. Insert back panel (D) into groove of left and right side panel (B) and screw L-shape bracket to the frame and top&bottom panel.

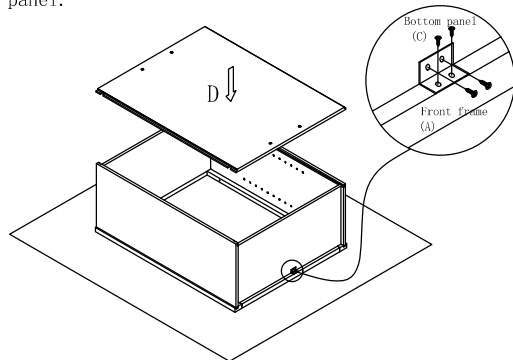

Step 5 : Screw rainbow bracket into front frame(A) and side panel(B).

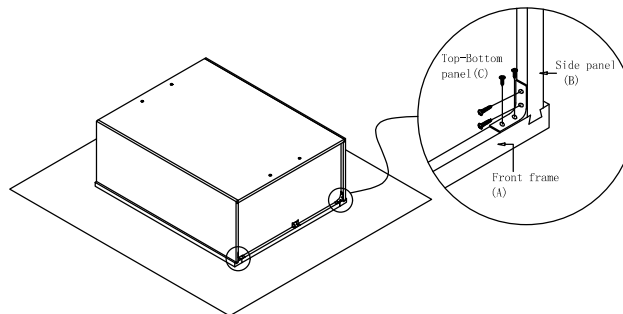

Step 6 : Install screw(5) $\varnothing 3.5 \times 35 \text{mm}$ into back panel (D), then nails side panel (B) and back panel (C) using nail gun.

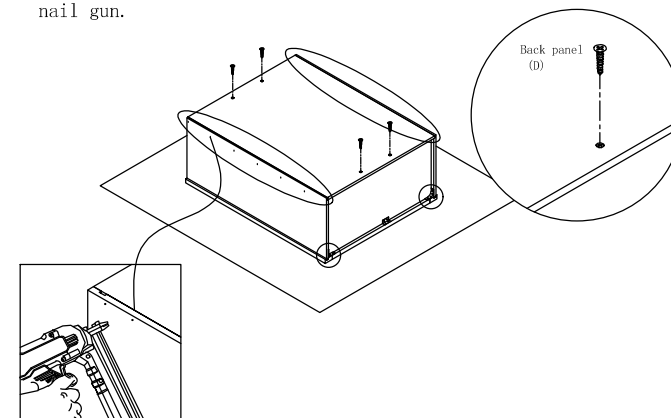

Wall Cabinet Assembly Instruction W2430-W3330 W2436-W3336

Step 7 : Install rainbow bracket. Screw the rainbow bracket to the side panel(B) and front frame(A) and also screw the L-shape bracket to the front frame(A) and top panel(C).

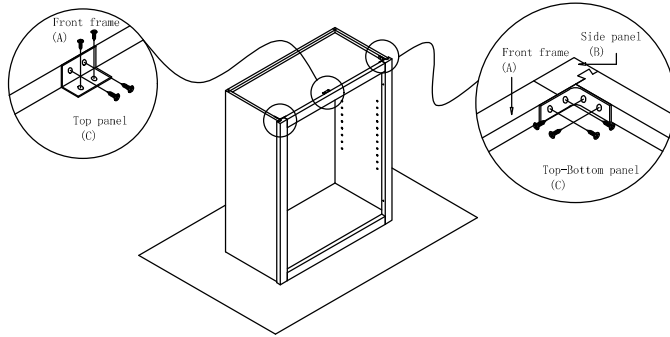

Step 8 : Install shelf clips. Install shelf clip to the side panel (B).

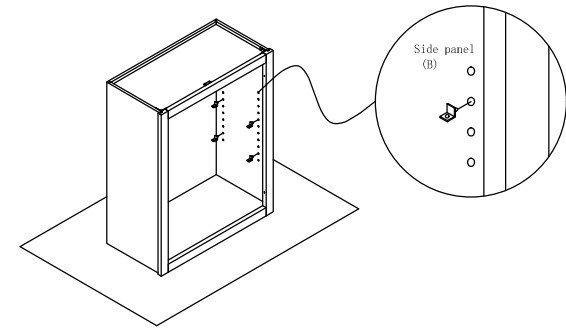

Step 9 : Install adjustable shelf. Put adjustable shelf (E) to the shelf clip.

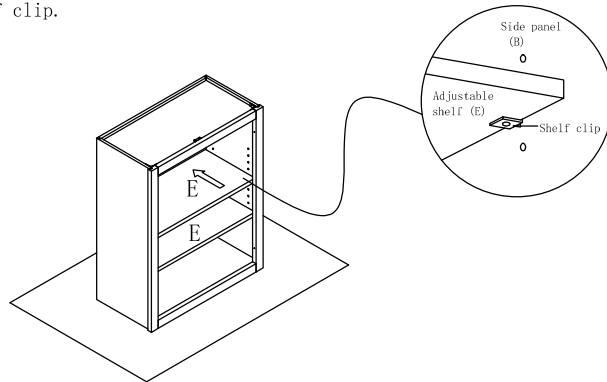

Step 10 : Install door. Screw the hinge to the door (F) and front frame (A).

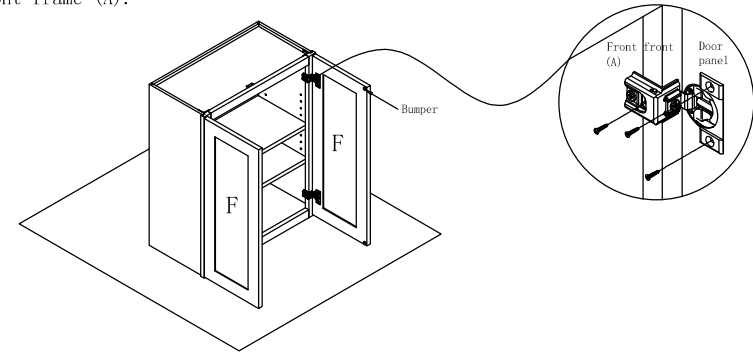

Step 11 : Finish installation of cabinet.

